

ROYALOHM

C O N F I D E N T I A L D O C U M E N T

SPECIFICATION FOR APPROVAL

Description : Thin Film Chip Resistors (Terminal Lead Free)

Royalohm Part no.:

TCxxxxxxxxTxx (TC Series +/-0.01%, 0.05%, 0.1%, 0.25%, 0.5%, 1%)

Approved by

RoHS V3 Compliant (EU) 2015/863
REACH Compliant

Royal Electronic Factory (Thailand) Co., Ltd.
20/1-2 Moo 2 Klong-Na, Muang
Chachoengsao 24000, Thailand
Tel: +66-38-822404-8
Fax: +66 38-981190 / 823765
E-mail Address: Export sales: Export@royalohm.com
Local sales: Local@royalohm.com

<http://www.royalohm.com>

P.O. Box 251 Klongchan, Bangkok 10240, Thailand

Approved	Checked	Prepared
Mr. XP Hong	Mr. S. Polthanasan	Ms. P. Supatta

Issue Date: 2021/07/13

Thin Film Chip Resistors (Terminal Lead Free)

1. Scope:

This specification for approval relates to Thin Film Chip Resistors (Terminal Lead Free) manufactured by ROYALOHM 's specifications.

2. Type designation:

The type designation shall be in the following form:

Type	Power Rating	Resistance tolerance	Nominal Resistance
Ex. TC05	0.125W	F	10Ω

3. Ratings:

Type	Power Rating (W)	Max. Working Voltage	Max. Overload Voltage	Dielectric Withstanding Voltage	Temperature Range	Ambient Temperature
TC02 (0402)	0.0625W (1/16W)	25 V	50 V	Max. Overload Voltage or $2.5 \sqrt{P \times R}$ whichever is lesser	-55°C ~ +155°C	70 °C
TC03 (0603)	0.10W (1/10W)	75 V	150 V			
TC05 (0805)	0.125 (1/8W)	150 V	300 V			
TC06 (1206)	0.25W (1/4W)	200 V	400 V			
TC07 (1210)	0.33W (1/3W)					
TC10 (2010)	0.5W (1/2W)					
TC12 (2512)	0.75W (3/4W)					

3.1 Nominal Resistance

Effective figures of nominal resistance shall be in accordance :

E-24 values – these are preferred and will have standard MOQ

E-96 values – are available on case by case basis and availability and MOQ need to be confirmed with factory first

Thin Film Chip Resistors (Terminal Lead Free)

3.2 Voltage rating:

Resistors shall have a rated direct-current (DC) continuous working voltage or an approximate sine-wave root-mean-square (RMS) alternating-current (AC) continuous working voltage at commercial-line frequency and waveform corresponding to the power rating , as determined from the following formula :

$$RCWV = \sqrt{P \times R}$$

Note : Max. Working Voltage or $\sqrt{P \times R}$ whichever is lesser

Max. Overload Voltage or $2.5 \sqrt{P \times R}$ whichever is lesser

Where : RCWV = Rated DC or RMS AC continuous working voltage at commercial-line frequency and waveform (volt)

P = Power Rating (watt)

R = Nominal Resistance (ohm)

4. Construction :

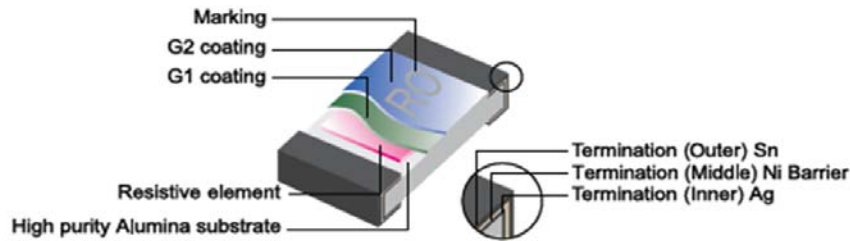

5. Power rating and dimensions

5.1 Power rating:

Resistors shall have a power rating based on continuous load operation at an ambient temperature of 70 °C . For temperature in excess of 70 °C , The load shall be derate as shown in figure 1.

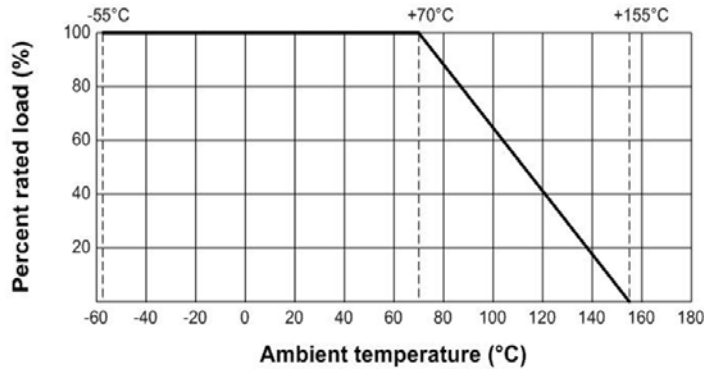

Thin Film Chip Resistors (Terminal Lead Free)

5.2 Dimension

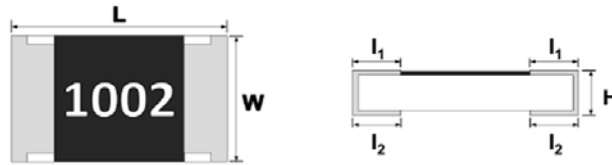

Dimension :

Type	Dimension (mm)				
	L	W	H	l1	l2
TC02 (0402)	1.00 ± 0.10	0.50 ± 0.05	0.30 ± 0.05	0.20 ± 0.10	0.20 ± 0.10
TC03 (0603)	1.60 ± 0.15	0.80 ± 0.10	0.45 ± 0.10	0.30 ± 0.20	0.30 ± 0.20
TC05 (0805)	2.00 ± 0.15	1.25 ± 0.15	0.55 ± 0.10	0.35 ± 0.20	0.40 ± 0.20
TC06 (1206)	3.10 ± 0.15	1.60 ± 0.15		0.45 ± 0.20	0.50 ± 0.20
TC07 (1210)	3.10 ± 0.15	2.50 ± 0.15		0.60 ± 0.20	0.60 ± 0.20
TC10 (2010)	5.00 ± 0.15				
TC12 (2512)	6.30 ± 0.15	3.20 ± 0.15			

Power Rating :

Type	Power Rating at 70 °C	Resistance Range (Ω)			T.C.R (PPM/°C)
		Tolerance (%)			
		± 0.01 ± 0.05	± 0.1 ± 0.25	± 0.5 ± 1	
TC02 (0402)	0.0625 W (1/16W)	50Ω - 12kΩ			± 10
		10Ω - 332kΩ			± 25
					± 50
TC03 (0603)	0.10 W (1/10W)	10Ω - 50kΩ			± 10
		4.7Ω - 332kΩ	4.7Ω - 1MΩ	1Ω - 1MΩ	± 25
					± 50
TC05 (0805)	0.125 W (1/8W)	10Ω - 100kΩ			± 10
		4.7Ω - 511kΩ	4.7Ω - 2MΩ	1Ω - 2MΩ	± 25
					± 50
TC06 (1206)	0.25 W (1/4W)	10Ω - 200kΩ			± 10
		4.7Ω - 1MΩ	4.7Ω - 3MΩ	1Ω - 3MΩ	± 25
					± 50
TC07 (1210)	0.33 W (1/3W)	10Ω - 200kΩ			± 10
		4.7Ω - 1MΩ	4.7Ω - 3MΩ	1Ω - 3MΩ	± 25
					± 50
TC10 (2010)	0.5 W (1/2W)	50Ω - 200kΩ			± 10
		4.7Ω - 1MΩ	4.7Ω - 3MΩ	1Ω - 3MΩ	± 25
					± 50
TC12 (2512)	0.75 W (3/4W)	50Ω - 200kΩ			± 10
		10Ω - 1MΩ	4.7Ω - 3MΩ	1Ω - 3MΩ	± 25
					± 50

Thin Film Chip Resistors (Terminal Lead Free)

6. Marking :

6.1 Resistors

A. Chip Resistors type TC02 No marking

B. ± 1% Tolerance TC03 E-96 series use below decoding method:

Mutiplier Code :

Code	A	B	C	D	E	F	G	H	X	Y	Z
Multiplier	10 ⁰	10 ¹	10 ²	10 ³	10 ⁴	10 ⁵	10 ⁶	10 ⁷	10 ⁻¹	10 ⁻²	10 ⁻³

Coding	Formula	Example :
$\underline{\text{XX}}$ Resistance Code	$\underline{\text{X}}$ Multiplier Code	$10.2\text{K}\Omega = \begin{matrix} 102 \\ \downarrow \\ 02 \end{matrix} \times \begin{matrix} 10 \\ \downarrow \\ C \end{matrix} \Omega = 02C$ $33.2\Omega = \begin{matrix} 332 \\ \downarrow \\ 31 \end{matrix} \times \begin{matrix} 10 \\ \downarrow \\ X \end{matrix} \Omega = 51X$

Value	Code	Value	Code	Value	Code	Value	Code	Value	Code
100	01	162	21	261	41	422	61	681	81
102	02	165	22	267	42	432	62	698	82
105	03	169	23	274	43	442	63	715	83
107	04	174	24	280	44	453	64	732	84
110	05	178	25	287	45	464	65	750	85
113	06	182	26	294	46	475	66	768	86
115	07	187	27	301	47	487	67	787	87
118	08	191	28	309	48	499	68	806	88
121	09	196	29	316	49	511	69	825	89
124	10	200	30	324	50	523	70	845	90
127	11	205	31	332	51	536	71	866	91
130	12	210	32	340	52	549	72	887	92
133	13	215	33	348	53	562	73	909	93
137	14	221	34	357	54	576	74	931	94
140	15	226	35	365	55	590	75	953	95
143	16	232	36	374	56	604	76	976	96
147	17	237	37	383	57	619	77		
150	18	243	38	392	58	634	78		
154	19	249	39	402	59	649	79		
158	20	255	40	412	60	665	80		

*For ohmic values below 100 Ω, letter "R" is for decimal point.

Ex.

	01C	
--	-----	--

 10kΩ

*The resistance value that no have multiplier code indicate marking follow this:
 The first 2 digits are significant figures of resistance and the 3rd digits denoted number of zeros
 and under line the marking letters.

Ex.

	<u>1R2</u>	
--	------------	--

 1.2Ω

B. Marking for 2% , 5% series in 0603 size : 3 Digits

*The first 2 digits are significant figures of resistance and the 3rd digit denoted number of zeros.

Ex.

	102	
--	-----	--

 1KΩ

Thin Film Chip Resistors (Terminal Lead Free)

C. Marking For E-96 Tolerance TC05, TC06,TC07, TC10, TC12 : 4 Digits,
 the first three digits are significant figures of resistance and the fourth digit denoted number of zeros.
 Letter "R" is for decimal point.

Ex.

	2701	
--	------	--

 2.7KΩ

*For ohmic values below 100 Ω, letter "R" is for decimal point.

Ex.

	1R80	
--	------	--

 1.8Ω

6.2 Labels

Label shall be marked with the following item :

- A. Nominal Resistance and Resistance Tolerance
- B. Power Rating and Size
- C. Quantity
- D. Part No.
- E. P.O.No.
- F. Lot No.
- F. Lot No.

Ex.

ROYALOHM	
CHIP RESISTOR	
RESISTANCE: 10Ω	± 0.1 %
WATTAGE: 1/8W	SIZE: TC05
QUANTITY: 5,000 PCS	PPM: 25 PPM
PART NO.: TC0525D100JT5G	
P.O.NO.:	
LOT NO. : 825723	
	
Pb-Free	

Remark : Label is 10R, value is 10Ω, marking is 10R0

Thin Film Chip Resistors (Lead Free)		
7. Performance specification :		
Characteristics	Limits	Test Methods
Temperature Coefficient	Refer to Standard Electrical Specification	Natural resistance change per temp. degree centigrade. $\frac{R_2 - R_1}{R_1(t_2 - t_1)} \times 10^6 \text{ (PPM/}^\circ\text{C)}$ R ₁ : Resistance value at room temperature(t ₁) R ₂ : Resistance value at room temp. plus 100 °C (t ₂)
Short-time Overload	ΔR ± 0.2%	Permanent resistance change after the application of 2.5 times RCWV for 5 seconds.
Insulation Resistance	≥10GΩ	Apply 100V dc for 1 minute
Endurance	ΔR ± 0.2%	70 ± 2 °C, RCWV for 1000 hours with 1.5 hours "ON" and 0.5 hour "OFF"
Damp heat with Load	ΔR ± 0.3%	40 ± 2 °C, 90 ~ 95% R.H. RCWV for 1000 hours with 1.5 hours "ON" and 0.5 hour "OFF"
Bending Strength	ΔR ± 0.1%	Bending amplitude for 10 seconds. 2010 and 2512 sizes: 2 mm Other sizes: 3 mm
Solderability	95% min. coverage	245±5°C for 3 seconds
Resistance to Soldering Heat	ΔR ± 0.1%	260±5°C for 10 seconds
Dielectric Withstanding Voltage	No short or burned on the appearance	Max. overload voltage for 1 minute
Low Temperature Operation	ΔR ± 0.2%	1 hour, - 65 °C, followed by 45 minutes of RCWV
High Temperature Exposure	ΔR ± 0.5%	+155 °C for 1000 hours

●RCWV (Rated Continuous Working Voltage) = √(P*R) or Max. Operating voltage whichever is lower.

Thin Film Chip Resistors (Lead Free)

Recommended Customer Soldering Parameters

- Wave solder Temperature condition

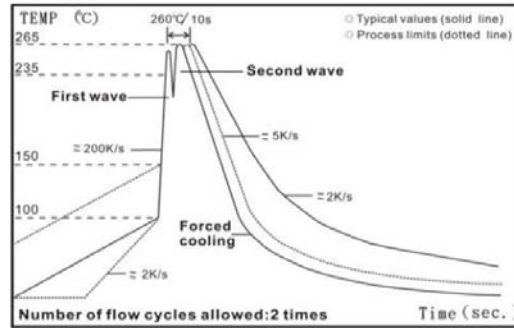

- Solder reflow Temperature condition

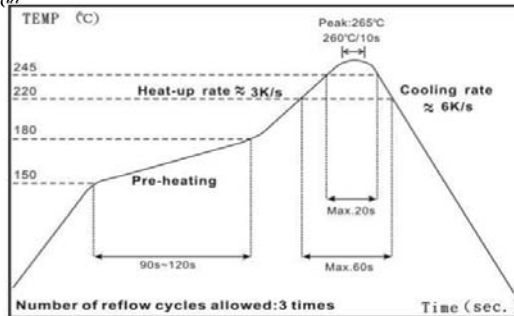

- Rework temperature (hot air equipment) : 350°C, 3-5seconds

- Recommended reflow methods

IR, vapor phase oven, hot air oven

If reflow temperatures exceed the recommended profile, devices may not meet the performance requirements.

- Recommend Land Pattern Design

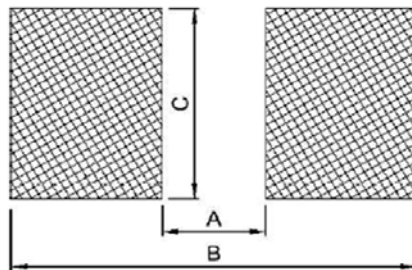

Unit: mm

Type Item	TC02	TC03	TC05	TC06	TC07	TC10	TC12
A	0.50	0.80	1.30	2.20	2.00	3.80	4.90
B	1.60	2.40	2.90	4.20	4.40	6.60	8.10
C	0.70	1.00	1.40	1.70	2.70	2.70	3.40

Thin Film Chip Resistors (Terminal Lead Free)

8. Packing specification :

* Taping Dimension (mm)

A. Paper taping

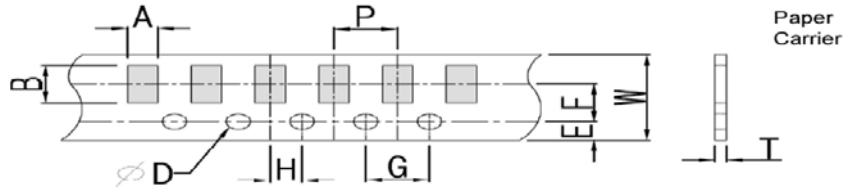

Type	A	B	W	E	F	G	H	T	ψD	P
TC02 (0402)	0.70±0.10	1.20±0.10	8.0±0.20	1.75±0.10	3.5±0.05	4.0±0.10	2.0±0.05	0.45±0.10	1.5+0.10 -0	2.0±0.10
TC03 (0603)	1.05±0.20	1.80±0.20						0.60±0.10		4.0±0.10
TC05 (0805)	1.55±0.20	2.30±0.20						0.75±0.10		
TC06 (1206)	1.90±0.20	3.50±0.20								
TC07 (1210)	2.85±0.20									

B. Embossed taping

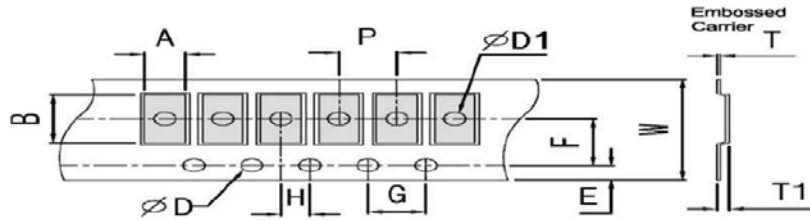

Type	A	B	W	E	F	G	H	T	ψD	$\psi D1$
TC10 (2010)	2.8±0.20	5.6±0.20	12±0.10	1.75±0.10	5.5±0.05	4.0±0.10	2.0±0.05	0.23±0.10	1.5+0.10 -0	1.5±0.10
TC12 (2512)	3.40±0.20	6.7±0.20								

Type	T1	P
TC10 (2010)	0.85±0.15	4.0±0.10
TC12 (2512)		

Thin Film Chip Resistors (Terminal Lead Free)

*** Peeling Strength of Top Cover Tape**

Test Condition: 0.1 to 0.7 N at a peel-off speed of 300 mm / min.

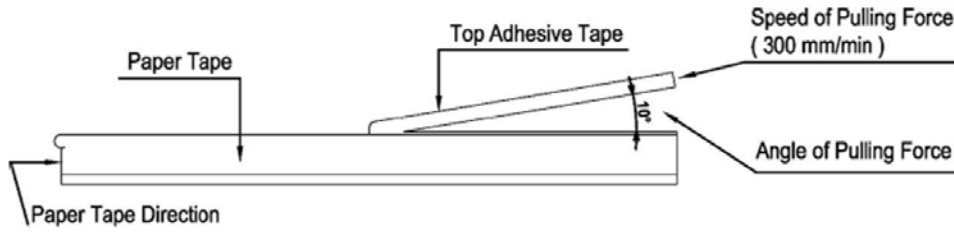

*** Reel Dimension (mm)**

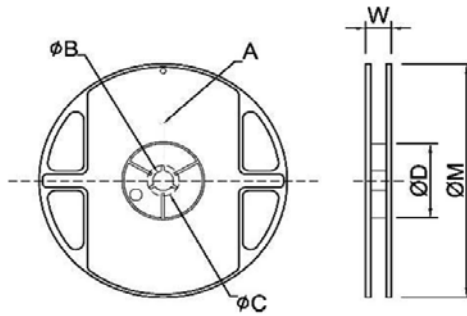

Type	Size	A	ψB	ψC	ψD	W	ψM
TC02 (0402)	10kpcs./Reel	2.0±0.5	13.5±1.0	21±1.0	60±1.0	11.5±2.0	178±2.0
TC03 (0603)	5kpcs./Reel						
TC05 (0805)							
TC06 (1206)							
TC07 (1210)							
TC10 (2010)							
TC12 (2512)	4kpcs./Reel					16.0±2.0	

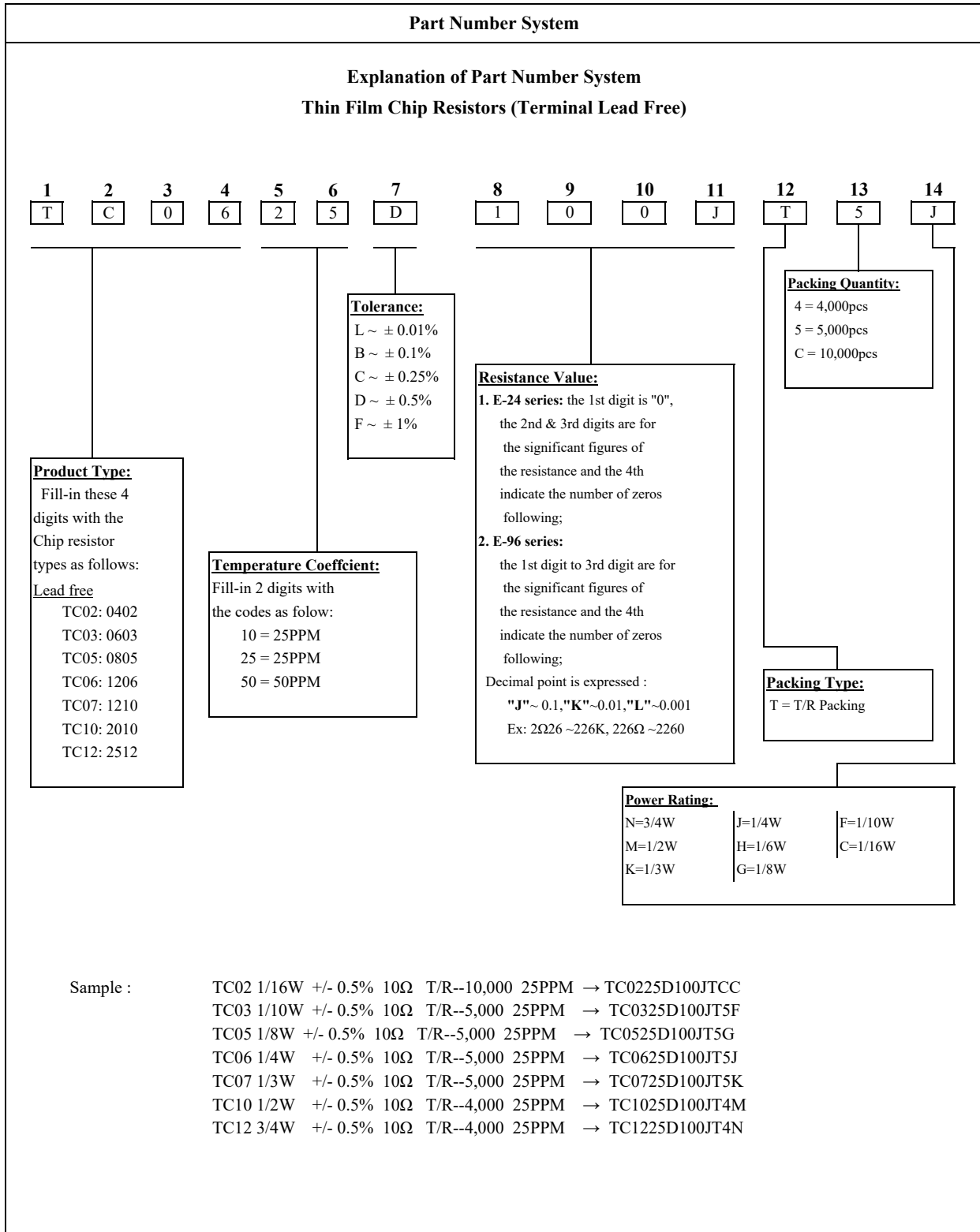

Thin Film Chip Resistors (Lead Free)

Environment Related Substance

This product complies to EU RoHS directive, EU PAHs directive, EU PFOS directive and Halogen free.

Ozone layer depleting substances.

Ozone depleting substances are not used in our manufacturing process of this product.

This product is not manufactured using Chloro fluorocarbons (CFCs), Hydrochlorofluorocarbons (HCFCs), Hydrobromofluorocarbons (HBFCs) or other ozone depleting substances in any phase of the manufacturing process.

Storage Condition (MSL1)

The performance of these products, including the solderability, is guaranteed for a year from the date of arrival at your company, provided that they remain packed as they were when delivered and stored at a temperature of $25^{\circ}\text{C} \pm 10^{\circ}\text{C}$ and a relative humidity of $60\%\text{RH} \pm 10\%\text{RH}$, chemical and dust free atmosphere

Even within the above guarantee periods, do not store these products in the following conditions.

Otherwise, their electrical performance and/or solderability may be deteriorated, and the packaging materials (e.g. taping materials) may be deformed or deteriorated, resulting in mounting failures.

1. In salty air or in air with a high concentration of corrosive gas such as Cl_2 , H_2S , NH_3 , SO_2 , or NO_2
2. In direct sunlight